

CRASH SUSPENSION

D131065- _____
 base number

- To build a product code in our configurator select the specify button on the base model # product page
- To build a manual product code on this datasheet choose from the options listed below in blue font and add the suffix to the base model #

GENERAL

Series: Crash
 Brand: Knikerboker
 Division: Design
 Mounting Type: Suspension
 Mounting Location: Ceiling
 Subcategory: Pendant

PHYSICAL

Shape: Abstract
 Length (mm): 1000
 Length (in): 39 ³/₁₆
 Width (mm): 1000
 Width (in): 39 ³/₁₆
 Max. Overall Height (mm): 2000
 Max. Overall Height (in): 78 ³/₄
 Light Distribution: Indirect
 Fixture Finish: EWH / EBK / MAN / COF / PRD / SLF / GLF / CLF / BRL / EWS / EWG / EWC / EWR / EBS / EBG / EBC / EBC / EBB / MAS / MAD / MAC / MAB / COS / CGO / CCL / CBL / PRS / PRG / PRC / PRB
 Fixture Material: Metal
 Cable Details: 4 Steel Cable 2000mm / 78 3/4" - Silicon Cable 2000mm / 78 3/4"

ELECTRICAL

Lamp Type: LED Retrofit
 Input Wattage (W): 21
 Total Output Wattage (W): 20
 Dimming: Tri-Mode (Non-Dimming and Phase Dimming (120Vac only) and 0-10V Dimming)
 Driver Included: Yes
 Driver Location: Integrated
 Driver Type: Constant Current - Universal
 Driver Class: Class 2
 Input Voltage (V): 120 - 277
 Constant Current (MA): 250
 Upon Request: 0-10Vdc dimming / Phase dimming @120Vac / 277Vac

LED

Number of LEDs: 2
 Color Temperature (°K): 3000
 Max. Delivered Lumen (lm): 2200
 CRI: >85 CRI
 Lamp Life (hrs): 50000

OPTICAL

RATINGS AND CERTIFICATIONS

Certified By: Certified for North American Standards
 IP rating: IP20

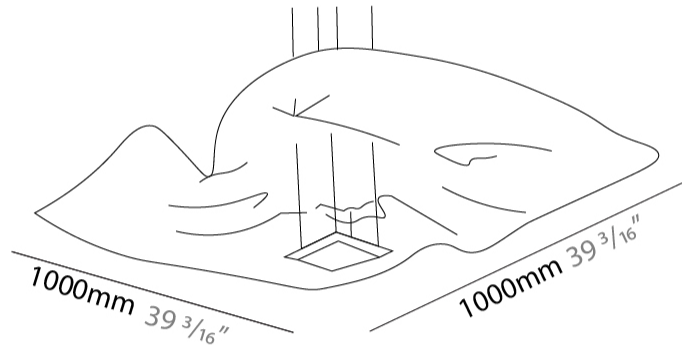

CRASH SUSPENSION

D131065-

PROJECT _____

TYPE _____

SPECIFIER _____

QUANTITY _____

DATE _____



D

CRASH SUSPENSION

D131068- _____
base number

PROJECT
TYPE
SPECIFIER
QUANTITY
DATE

- To build a product code in our configurator select the specify button on the base model # product page
- To build a manual product code on this datasheet choose from the options listed below in blue font and add the suffix to the base model #

GENERAL

Series: Crash
 Brand: Knikerboker
 Division: Design
 Mounting Type: Suspension
 Mounting Location: Ceiling
 Subcategory: Pendant

PHYSICAL

Shape: Curves
 Length (mm): 1500
 Length (in): 59 1/16
 Width (mm): 1500
 Width (in): 59 1/16
 Max. Overall Height (mm): 2000
 Max. Overall Height (in): 78 3/4
 Light Distribution: Indirect
 Fixture Finish: EWH / EBK / MAN / COF / PRD / SLF / GLF / CLF / BRL / EWS / EWG / EWC / EWR / EBS / EBG / EBC / EBC / EBB / MAS / MAD / MAC / MAB / COS / CGO / CCL / CBL / PRS / PRG / PRC / PRB
 Fixture Material: Metal
 Cable Details: 4 Steel Cable 2000mm / 78 3/4" - Silicon Cable 2000mm / 78 3/4"

ELECTRICAL

Lamp Type: LED
 Input Wattage (W): 31.5
 Total Output Wattage (W): 30
 Dimming: Tri-Mode (Non-Dimming and Phase Dimming (120Vac only) and 0-10V Dimming)
 Driver Included: Yes
 Driver Location: Integrated
 Driver Type: Constant Current - Universal
 Driver Class: Class 2
 Input Voltage (V): 120 - 277
 Constant Current (MA): 250
 Upon Request: 0-10Vdc dimming / Phase dimming @120Vac / 277Vac

LED

Number of LEDs: 3
 Color Temperature (°K): 3000
 Max. Delivered Lumen (lm): 3300
 CRI: >85 CRI
 Lamp Life (hrs): 50000

OPTICAL

RATINGS AND CERTIFICATIONS

Certified By: Certified for North American Standards
 IP rating: IP20

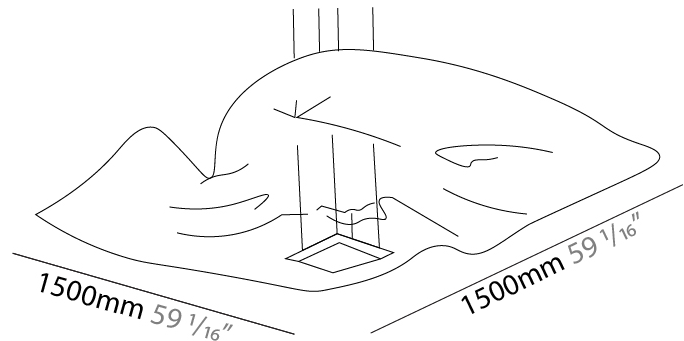

CRASH SUSPENSION

D131068-

PROJECT _____

TYPE _____

SPECIFIER _____

QUANTITY _____

DATE _____



D

PROJECT	_____
TYPE	_____
SPECIFIER	_____
QUANTITY	_____
DATE	_____

CRASH SUSPENSION

D131071- _____
base number

- To build a product code in our configurator select the specify button on the base model # product page
- To build a manual product code on this datasheet choose from the options listed below in blue font and add the suffix to the base model #

GENERAL

Series: Crash
 Brand: Knikerboker
 Division: Design
 Mounting Type: Suspension
 Mounting Location: Ceiling
 Subcategory: Pendant

PHYSICAL

Shape: Curves
 Length (mm): 2500
 Length (in): 98 7/16
 Width (mm): 620
 Width (in): 24 7/16
 Max. Overall Height (mm): 2000
 Max. Overall Height (in): 78 3/4
 Light Distribution: Indirect
 Fixture Finish: EWH / EBK / MAN / COF / PRD / SLF / GLF / CLF / BRL / EWS / EWG / EWC / EWR / EBS / EBG / EBC / EBC / EBB / MAS / MAD / MAC / MAB / COS / CGO / CCL / CBL / PRS / PRG / PRC / PRB
 Fixture Material: Metal
 Cable Details: 4 Steel Cable 2000mm / 78 3/4" - Silicon Cable 2000mm / 78 3/4"

ELECTRICAL

Lamp Type: LED
 Input Wattage (W): 42
 Total Output Wattage (W): 40
 Dimming: Tri-Mode (Non-Dimming and Phase Dimming (120Vac only) and 0-10V Dimming)
 Driver Included: Yes
 Driver Location: Integrated
 Driver Type: Constant Current - Universal
 Driver Class: Class 2
 Input Voltage (V): 120 - 277
 Constant Current (MA): 250
 Upon Request: 0-10Vdc dimming / Phase dimming @120Vac / 277Vac

LED

Number of LEDs: 4
 Color Temperature (°K): 3000
 Max. Delivered Lumen (lm): 4400
 CRI: >85 CRI
 Lamp Life (hrs): 50000

OPTICAL

RATINGS AND CERTIFICATIONS

Certified By: Certified for North American Standards
 IP rating: IP20

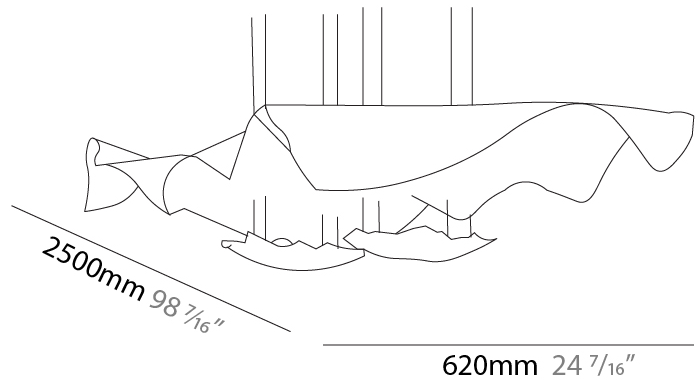
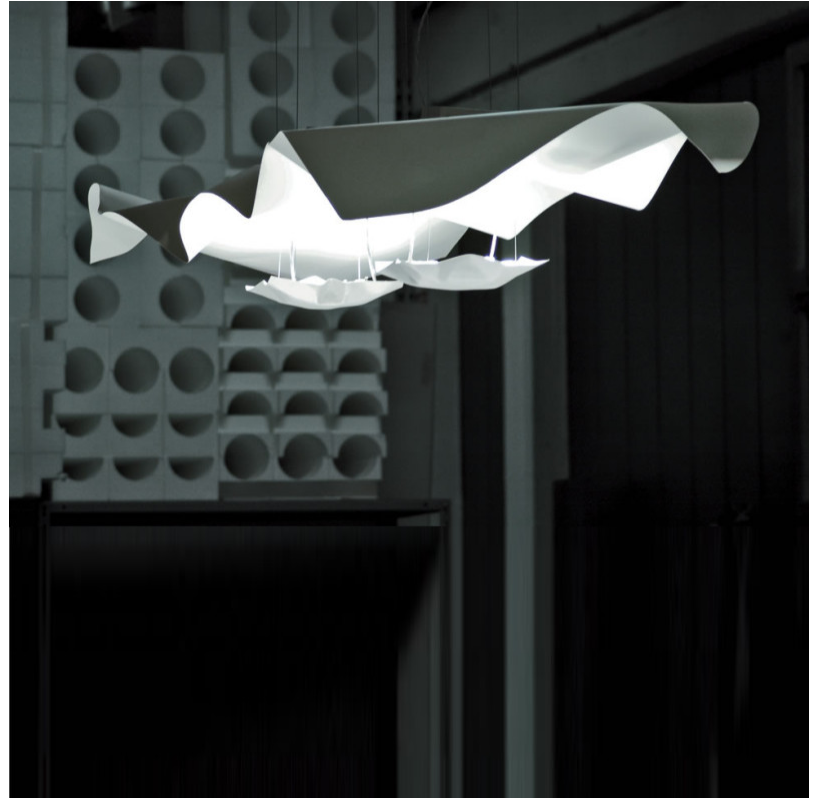

CRASH SUSPENSION

D131071-

PROJECT _____

TYPE _____

SPECIFIER _____

QUANTITY _____

DATE _____

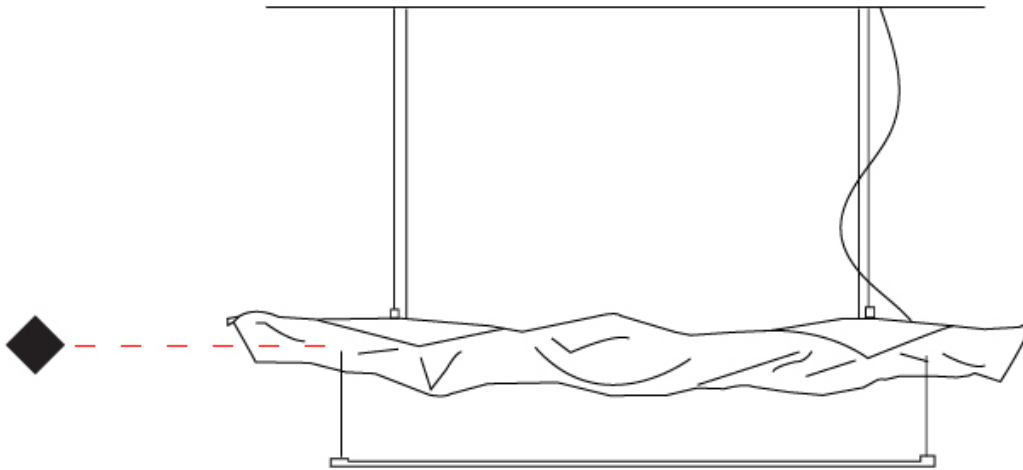

D

PROJECT	_____
TYPE	_____
SPECIFIER	_____
QUANTITY	_____
DATE	_____

CRASH SUSPENSION

D131425- _____
base number

- To build a product code in our configurator select the specify button on the base model # product page
- To build a manual product code on this datasheet choose from the options listed below in blue font and add the suffix to the base model #

GENERAL

Series: Crash
 Brand: Knikerboker
 Division: Design
 Mounting Type: Suspension
 Mounting Location: Ceiling
 Subcategory: Pendant

PHYSICAL

Shape: Abstract
 Length (mm): 500
 Length (in): 19 ¹¹/₁₆
 Width (mm): 500
 Width (in): 19 ¹¹/₁₆
 Extension (mm): 2000
 Extension (in): 78 ³/₄
 Light Distribution: Indirect
 Fixture Finish: EWH / EBK / MAN / COF / PRD / SLF / GLF / CLF / BRL / EWS / EWG / EWC / EWR / EBS / EBG / EBC / EBC / EBB / MAS / MAD / MAC / MAB / COS / CGO / CCL / CBL / PRS / PRG / PRC / PRB
 Fixture Material: Metal
 Cable Detail: 4 Steel Cable 2000mm / 78 3/4" - Silicon Cable 2000mm / 78 3/4"

ELECTRICAL

Lamp Type: LED
 Input Wattage (W): 10.5
 Total Output Wattage (W): 10
 Dimming: Tri-Mode (Non-Dimming and Phase Dimming (120Vac only) and 0-10V Dimming)
 Driver Included: Yes
 Driver Location: Integrated
 Driver Type: Constant Current - Universal
 Driver Class: Class 2
 Input Voltage (V): 120 - 277
 Constant Current (MA): 250
 Upon Request: 0-10Vdc dimming / Phase dimming @120Vac / 277Vac

LED

Color Temperature (°K): 3000
 Max. Delivered Lumen (lm): 1100
 CRI: >85 CRI
 Lamp Life (hrs): 50000

OPTICAL

RATINGS AND CERTIFICATIONS

Certified By: Certified for North American Standards
 IP rating: IP20

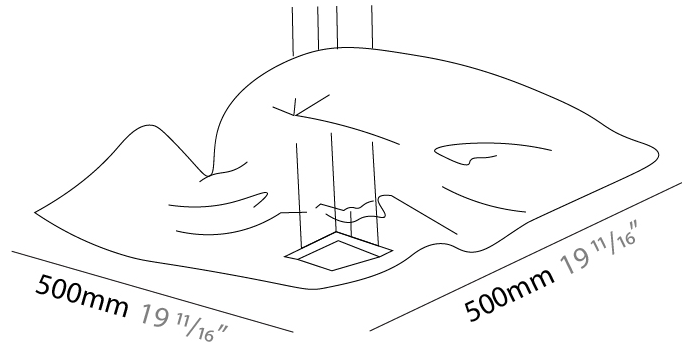

CRASH SUSPENSION

D131425-

PROJECT

TYPE

SPECIFIER

QUANTITY

DATE

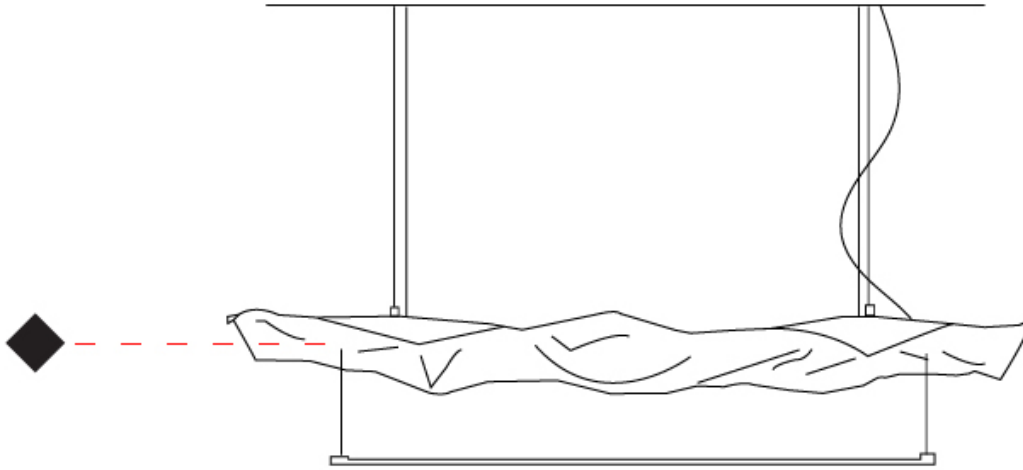

D

CRASH SUSPENSION

D131439- _____
 base number

- To build a product code in our configurator select the specify button on the base model # product page
- To build a manual product code on this datasheet choose from the options listed below in blue font and add the suffix to the base model #

GENERAL

Series: Crash
 Brand: Knikerboker
 Division: Design
 Mounting Type: Suspension
 Mounting Location: Ceiling
 Subcategory: Pendant

PHYSICAL

Shape: Abstract
 Length (mm): 1000
 Length (in): 39 ³/₈
 Width (mm): 750
 Width (in): 29 ¹/₂
 Max. Overall Height (mm): 2000
 Max. Overall Height (in): 78 ³/₄
 Light Distribution: Indirect
 Fixture Finish: EWH / EBK / MAN / COF / PRD / SLF / GLF / CLF / BRL / EWS / EWG / EWC / EWR / EBS / EBG / EBC / EBC / EBB / MAS / MAD / MAC / MAB / COS / CGO / CCL / CBL / PRS / PRG / PRC / PRB
 Fixture Material: Metal
 Cable Details: 4 Steel Cable 2000mm / 78 3/4" - Silicon Cable 2000mm / 78 3/4"

ELECTRICAL

Lamp Type: LED
 Input Wattage (W): 10.5
 Total Output Wattage (W): 10
 Dimming: Tri-Mode (Non-Dimming and Phase Dimming (120Vac only) and 0-10V Dimming)
 Driver Included: Yes
 Driver Location: Integrated
 Driver Type: Constant Current - Universal
 Driver Class: Class 2
 Input Voltage (V): 120 - 277
 Constant Current (MA): 250
 Upon Request: 0-10Vdc dimming / Phase dimming @120Vac / 277Vac

LED

Number of LEDs: 1
 Color Temperature (°K): 3000
 Max. Delivered Lumen (lm): 2200
 CRI: >85 CRI
 Lamp Life (hrs): 50000

OPTICAL

RATINGS AND CERTIFICATIONS

Certified By: Certified for North American Standards
 IP rating: IP20

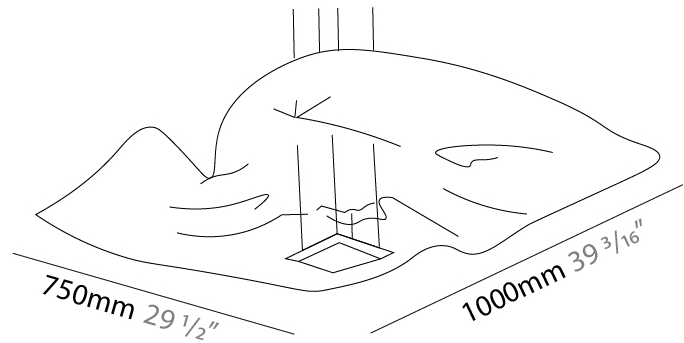

CRASH SUSPENSION

D131439-

PROJECT _____

TYPE _____

SPECIFIER _____

QUANTITY _____

DATE _____



D

CRASH SURFACE

D132044- _____
base number

PROJECT
TYPE
SPECIFIER
QUANTITY
DATE

- To build a product code in our configurator select the specify button on the base model # product page
- To build a manual product code on this datasheet choose from the options listed below in blue font and add the suffix to the base model #

GENERAL

Series: Crash
 Brand: Knikerboker
 Division: Design
 Mounting Type: Surface
 Mounting Location: Ceiling
 Subcategory: Ambient

PHYSICAL

Shape: Abstract
 Length (mm): 1000
 Length (in): 39 3/8
 Width (mm): 400
 Width (in): 15 3/4
 Height (mm): 240
 Height (in): 9 7/16
 Extension (mm): 250
 Extension (in): 9 13/16
 Light Distribution: Indirect
 Fixture Finish: EWH / EBK / MAN / COF / PRD / SLF / GLF / CLF / BRL / EWS / EWG / EWC / EWR / EBS / EBG / EBC / EBB / MAS / MAD / MAC / MAB / COS / CGO / CCL / CBL / PRS / PRG / PRC / PRB
 Fixture Material: Metal

ELECTRICAL

Lamp Type: LED
 Input Wattage (W): 10.5
 Total Output Wattage (W): 10
 Dimming: Tri-Mode (Non-Dimming and Phase Dimming (120Vac only) and 0-10V Dimming)
 Driver Included: Yes
 Driver Location: Integrated
 Driver Type: Constant Current - Universal
 Driver Class: Class 2
 Input Voltage (V): 120 - 277
 Constant Current (MA): 250
 Upon Request: 0-10Vdc dimming / Phase dimming @120Vac / 277Vac

LED

Number of LEDs: 1
 Color Temperature (°K): 3000
 Max. Delivered Lumen (lm): 2200
 CRI: >85 CRI
 Lamp Life (hrs): 50000

OPTICAL

RATINGS AND CERTIFICATIONS

Certified By: Certified for North American Standards
 IP rating: IP20

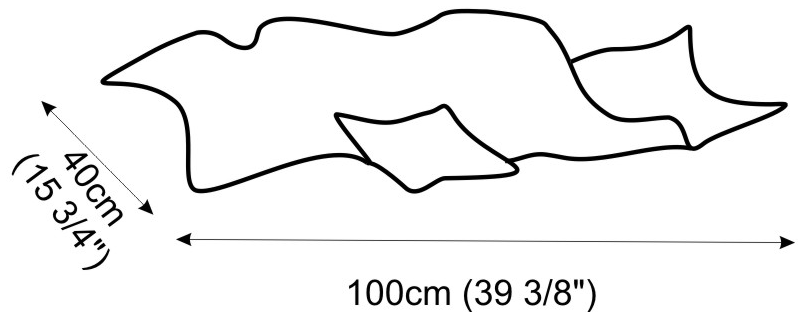

CRASH SURFACE

D132047- _____

base number

1. To build a product code in our configurator select the specify button on the base model # product page
2. To build a manual product code on this datasheet choose from the options listed below in blue font and add the suffix to the base model #

GENERAL

Series: Crash
Brand: Knikerboker
Division: Design
Mounting Type: Surface
Mounting Location: Ceiling

PHYSICAL

Shape: Rectangle
Length (mm): 300
Length (in): 11 ¹³/₁₆
Width (mm): 300
Width (in): 11 ¹³/₁₆
Light Distribution: Indirect
Fixture Finish: EWH / EBK / MAN / COF / PRD / SLF / GLF / CLF / BRL / EWS / EWG / EWC / EWR / EBS / EBG / EBC / EBC / EBB / MAS / MAD / MAC / MAB / COS / CGO / CCL / CBL / PRS / PRG / PRC / PRB
Fixture Material: Metal

ELECTRICAL

Lamp Type: LED
Input Wattage (W): 10.5
Total Output Wattage (W): 10
Dimming: Tri-Mode (Non-Dimming and Phase Dimming (120Vac only) and 0-10V Dimming)
Driver Included: Yes
Driver Location: Integrated
Driver Type: Constant Current - Universal
Driver Class: Class 2
Input Voltage (V): 120 - 277
Constant Current (MA): 250
Upon Request: 0-10Vdc dimming / Phase dimming @120Vac only / 277Vac

LED

Number of LEDs: 1
Color Temperature (°K): 3000
Max. Delivered Lumen (lm): 1100
CRI: >85 CRI
Lamp Life (hrs): 50000

OPTICAL

RATINGS AND CERTIFICATIONS

Certified By: Certified for North American Standards
IP rating: IP20

PROJECT	_____
TYPE	_____
SPECIFIER	_____
QUANTITY	_____
DATE	_____

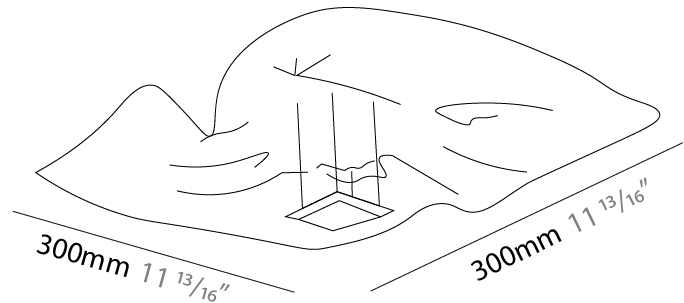

CRASH SURFACE

D132047-

PROJECT

TYPE

SPECIFIER

QUANTITY

DATE



CRASH SURFACE

D132050- _____

base number

1. To build a product code in our configurator select the specify button on the base model # product page
2. To build a manual product code on this datasheet choose from the options listed below in blue font and add the suffix to the base model #

GENERAL

Series: Crash _____
Brand: Knikerboker _____
Division: Design _____
Mounting Type: Surface _____
Mounting Location: Ceiling _____

PHYSICAL

Shape: Rectangle _____
Length (mm): 500 _____
Length (in): 19 ¹¹/₁₆ _____
Width (mm): 500 _____
Width (in): 19 ¹¹/₁₆ _____
Height (mm): 300 _____
Height (in): 11 ¹³/₁₆ _____
Light Distribution: Indirect _____
Fixture Finish: EWH / EBK / MAN / COF / PRD / SLF / GLF / CLF / BRL / EWS / EWG / EWC / EWR / EBS / EBG / EBC / EBC / EBB / MAS / MAD / MAC / MAB / COS / CGO / CCL / CBL / PRS / PRG / PRC / PRB _____
Fixture Material: Metal _____

ELECTRICAL

Lamp Type: LED _____
Input Wattage (W): 21 _____
Total Output Wattage (W): 20 _____
Dimming: Tri-Mode (Non-Dimming and Phase Dimming (120Vac only) and 0-10V Dimming) _____
Driver Included: Yes _____
Driver Location: Integrated _____
Driver Type: Constant Current - Universal _____
Driver Class: Class 2 _____
Input Voltage (V): 120 - 277 _____
Constant Current (MA): 250 _____

LED

Number of LEDs: 2 _____
Color Temperature (°K): 3000 _____
Max. Delivered Lumen (lm): 2200 _____
CRI: >85 CRI _____
Lamp Life (hrs): 50000 _____

OPTICAL

RATINGS AND CERTIFICATIONS

Certified By: Certified for North American Standards _____
IP rating: IP20 _____

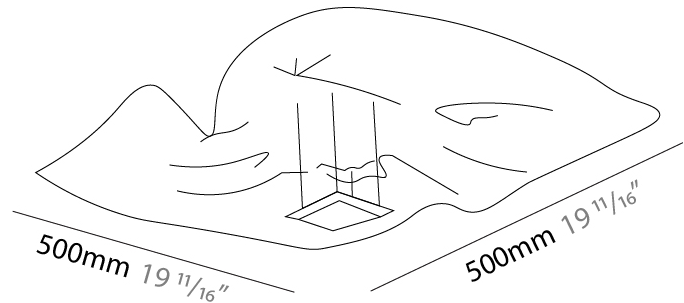

PROJECT	_____
TYPE	_____
SPECIFIER	_____
QUANTITY	_____
DATE	_____

CRASH SURFACE

D132053- _____
base number

- To build a product code in our configurator select the specify button on the base model # product page
- To build a manual product code on this datasheet choose from the options listed below in blue font and add the suffix to the base model #

GENERAL

Series: Crash
 Brand: Knikerboker
 Division: Design
 Mounting Type: Surface
 Mounting Location: Ceiling

PHYSICAL

Shape: Rectangle
 Length (mm): 750
 Length (in): 29 1/2
 Width (mm): 750
 Width (in): 29 1/2
 Extension (mm): 150
 Extension (in): 5 7/8
 Light Distribution: Indirect
 Fixture Finish: EWH / EBK / MAN / COF / PRD / SLF / GLF / CLF / BRL / EWS / EWG / EWC / EWR / EBS / EBG / EBC / EBC / EBB / MAS / MAD / MAC / MAB / COS / CGO / CCL / CBL / PRS / PRG / PRC / PRB
 Fixture Material: Metal

ELECTRICAL

Lamp Type: LED
 Input Wattage (W): 21
 Total Output Wattage (W): 20
 Dimming: Tri-Mode (Non-Dimming and Phase Dimming (120Vac only) and 0-10V Dimming)
 Driver Included: Yes
 Driver Location: Integrated
 Driver Type: Constant Current - Universal
 Driver Class: Class 2
 Input Voltage (V): 120 - 277
 Constant Current (MA): 250
 Upon Request: 0-10Vdc dimming / Phase dimming @120Vac / 277Vac

LED

Number of LEDs: 2
 Color Temperature (°K): 3000
 Max. Delivered Lumen (lm): 1100
 CRI: >85 CRI
 Lamp Life (hrs): 50000

OPTICAL

RATINGS AND CERTIFICATIONS

Certified By: Certified for North American Standards
 IP rating: IP20

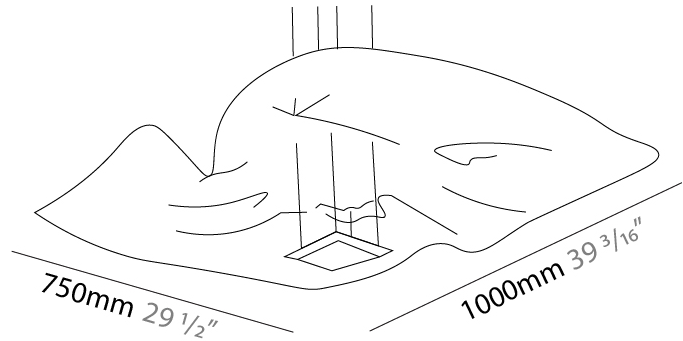

CRASH SURFACE

D132053-

PROJECT _____

TYPE _____

SPECIFIER _____

QUANTITY _____

DATE _____

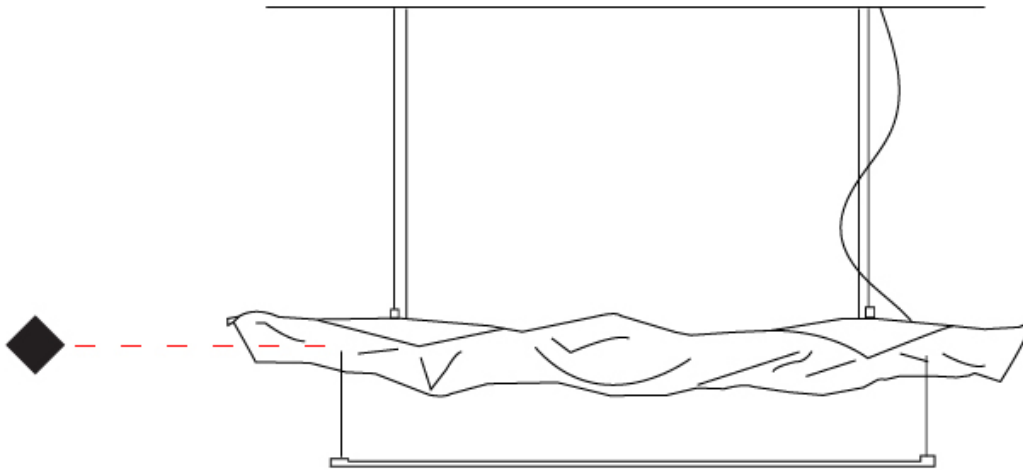

D

PROJECT	_____
TYPE	_____
SPECIFIER	_____
QUANTITY	_____
DATE	_____

CRASH SURFACE

D132056- _____
base number

- To build a product code in our configurator select the specify button on the base model # product page
- To build a manual product code on this datasheet choose from the options listed below in blue font and add the suffix to the base model #

GENERAL

Series: Crash _____
 Brand: Knikerboker _____
 Division: Design _____
 Mounting Type: Surface _____
 Mounting Location: Ceiling _____

PHYSICAL

Shape: Rectangle _____
 Length (mm): 1000 _____
 Length (in): 39 ³/₈ _____
 Width (mm): 1000 _____
 Width (in): 39 ³/₈ _____
 Height (mm): 250 _____
 Height (in): 9 ¹³/₁₆ _____
 Light Distribution: Indirect _____
 Fixture Finish: EWH / EBK / MAN / COF / PRD / SLF / GLF / CLF / BRL / EWS / EWG / EWC / EWR / EBS / EBG / EBC / EBC / EBB / MAS / MAD / MAC / MAB / COS / CGO / CCL / CBL / PRS / PRG / PRC / PRB _____
 Fixture Material: Metal _____

ELECTRICAL

Lamp Type: LED _____
 Input Wattage (W): 21 _____
 Total Output Wattage (W): 20 _____
 Dimming: Tri-Mode (Non-Dimming and Phase Dimming (120Vac only) and 0-10V Dimming) _____
 Driver Included: Yes _____
 Driver Location: Integrated _____
 Driver Type: Constant Current - Universal _____
 Driver Class: Class 2 _____
 Input Voltage (V): 120 - 277 _____
 Constant Current (MA): 250 _____
 Upon Request: 0-10Vdc dimming / Phase dimming @120Vac / 277Vac _____

LED

Number of LEDs: 2 _____
 Color Temperature (°K): 3000 _____
 Max. Delivered Lumen (lm): 1100 _____
 CRI: >85 CRI _____
 Lamp Life (hrs): 50000 _____

OPTICAL

RATINGS AND CERTIFICATIONS

Certified By: Certified for North American Standards _____
 IP rating: IP20 _____

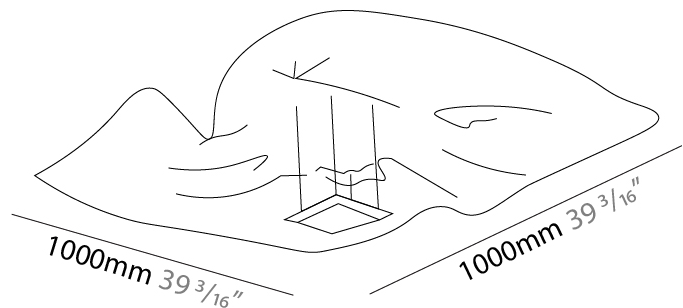

PROJECT
TYPE
SPECIFIER
QUANTITY
DATE

CRASH SURFACE

D132109- _____
base number

- To build a product code in our configurator select the specify button on the base model # product page
- To build a manual product code on this datasheet choose from the options listed below in blue font and add the suffix to the base model #

GENERAL

Series: Crash
 Brand: Knikerboker
 Division: Design
 Mounting Type: Surface
 Mounting Location: Ceiling
 Subcategory: Pendant

PHYSICAL

Shape: Abstract
 Length (mm): 200
 Length (in): 7 7/8
 Width (mm): 200
 Width (in): 7 7/8
 Height (mm): 250
 Height (in): 9 13/16
 Light Distribution: Indirect
 Fixture Finish: EWH / EBK / MAN / COF / PRD / SLF / GLF / CLF / BRL / EWS / EWG / EWC / EWR / EBS / EBG / EBC / EBB / MAS / MAD / MAC / MAB / COS / CGO / CCL / CBL / PRS / PRG / PRC / PRB
 Fixture Material: Metal

ELECTRICAL

Lamp Type: LED
 Input Wattage (W): 10.5
 Total Output Wattage (W): 10
 Dimming: Tri-Mode (Non-Dimming and Phase Dimming (120Vac only) and 0-10V Dimming)
 Driver Included: Yes
 Driver Location: Integrated
 Driver Type: Constant Current - Universal
 Driver Class: Class 2
 Input Voltage (V): 120 - 277
 Constant Current (MA): 250
 Upon Request: 0-10Vdc Dimming / Phase dimming @120Vac only / Non-dimming 120/277Vac

LED

Number of LEDs: 1
 Color Temperature (°K): 3000
 Max. Delivered Lumen (lm): 1100
 CRI: >85 CRI
 Lamp Life (hrs): 50000

OPTICAL

RATINGS AND CERTIFICATIONS

Certified By: Certified for North American Standards
 IP rating: IP20

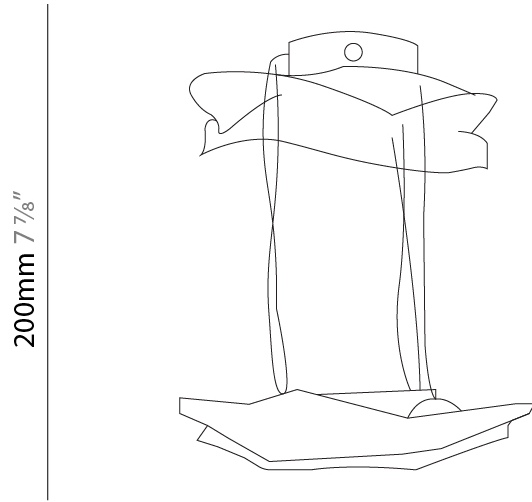
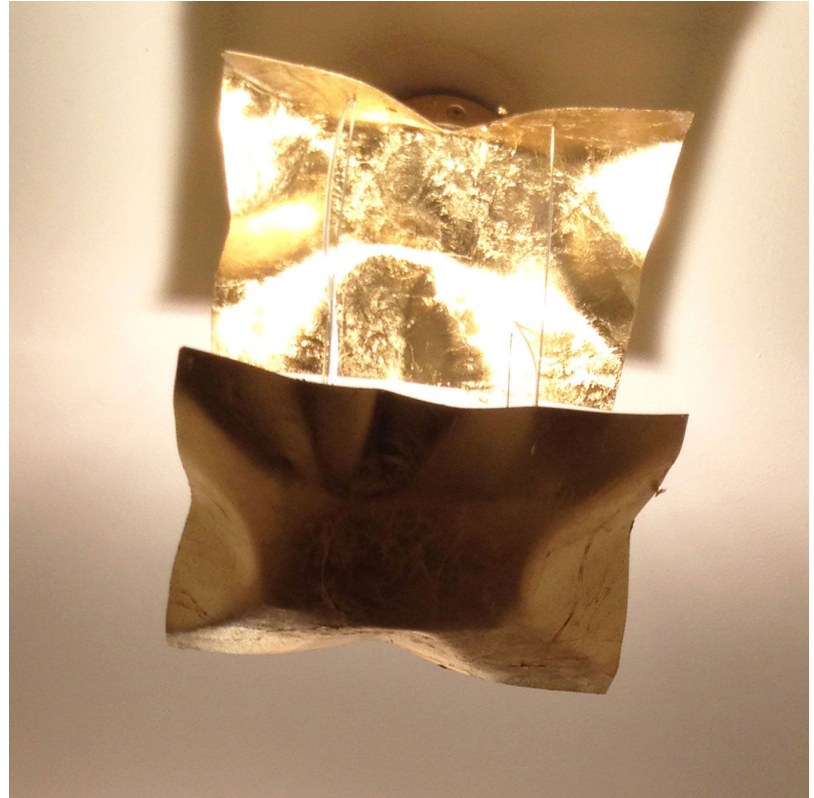

200mm 7 7/8"



CRASH SURFACE

D132109-

PROJECT	_____
TYPE	_____
SPECIFIER	_____
QUANTITY	_____
DATE	_____

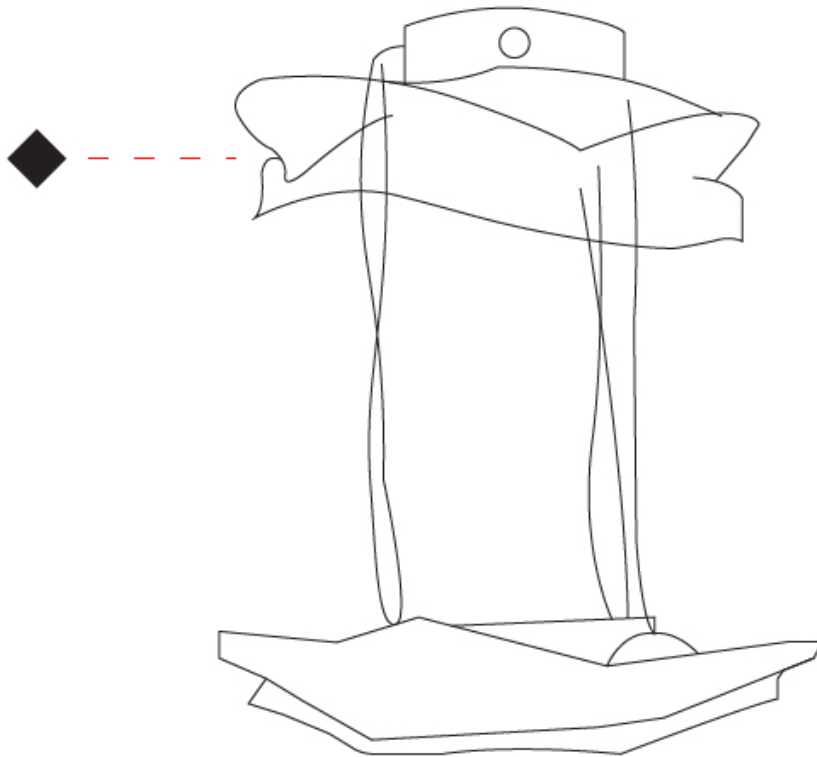

PROJECT
TYPE
SPECIFIER
QUANTITY
DATE

CRASH SURFACE

D133000-

base number Finish
Options

- To build a product code in our configurator select the specify button on the base model # product page
- To build a manual product code on this datasheet choose from the options listed below in blue font and add the suffix to the base model #

GENERAL

Series: Crash
 Brand: Knikerboker
 Division: Design
 Mounting Type: Surface
 Mounting Location: Wall
 Subcategory: Ambient

PHYSICAL

Shape: Square
 Length (mm): 750
 Length (in): 29 1/2
 Width (mm): 750
 Width (in): 29 1/2
 Extension (mm): 260
 Extension (in): 10 1/4
 Light Distribution: Indirect
 Fixture Finish: EWH / EBK / MAN / COF / PRD / SLF / GLF / CLF / BRL
 Fixture Material: Metal

ELECTRICAL

Lamp Type: LED
 Input Wattage (W): 10.5
 Total Output Wattage (W): 10
 Dimming: Tri-Mode (Non-Dimming and Phase Dimming (120Vac only) and 0-10V Dimming)
 Driver Included: Yes
 Driver Location: Integrated
 Driver Type: Constant Current - Universal
 Driver Class: Class 2
 Input Voltage (V): 120 - 277
 Constant Current (MA): 250
 Upon Request: 0-10Vdc dimming / Phase dimming @120Vac only / Non-dimming 120/277Vac

LED

Number of LEDs: 1
 Color Temperature (°K): 3000
 Max. Delivered Lumen (lm): 1100
 CRI: >85 CRI
 Lamp Life (hrs): 50000

OPTICAL

RATINGS AND CERTIFICATIONS

Certified By: Certified for North American Standards
 IP rating: IP20

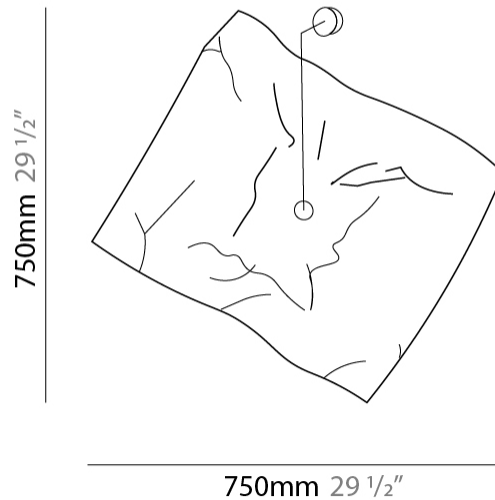

CRASH SURFACE

D133003-

base number Finish
Options

1. To build a product code in our configurator select the specify button on the base model # product page
2. To build a manual product code on this datasheet choose from the options listed below in blue font and add the suffix to the base model #

GENERAL

Series: Crash
Brand: Knikerboker
Division: Design
Mounting Type: Surface
Mounting Location: Wall
Subcategory: Ambient

PHYSICAL

Shape: Rectangle
Length (mm): 1000
Length (in): 39 ³/₈
Height (mm): 1000
Height (in): 39 ³/₈
Extension (mm): 260
Extension (in): 10 ¹/₄
Light Distribution: Indirect
[Fixture Finish: EWH / EBK / MAN / COF / PRD / SLF / GLF / CLF / BRL](#)
Fixture Material: Metal

ELECTRICAL

Lamp Type: LED
Input Wattage (W): 10.5
Total Output Wattage (W): 10
Dimming: Tri-Mode (Non-Dimming and Phase Dimming (120Vac only and 0-10V Dimming)
Driver Included: Yes
Driver Location: Integrated
Driver Type: Constant Current - Universal
Driver Class: Class 2
Input Voltage (V): 120 - 277
Constant Current (MA): 250
Upon Request: 0-10Vdc dimming / Phase dimming @120Vac / 277Vac

LED

Number of LEDs: 1
Color Temperature (°K): 3000
Max. Delivered Lumen (lm): 1100
CRI: >85 CRI
Lamp Life (hrs): 50000

OPTICAL

RATINGS AND CERTIFICATIONS

Certified By: Certified for North American Standards
IP rating: IP20

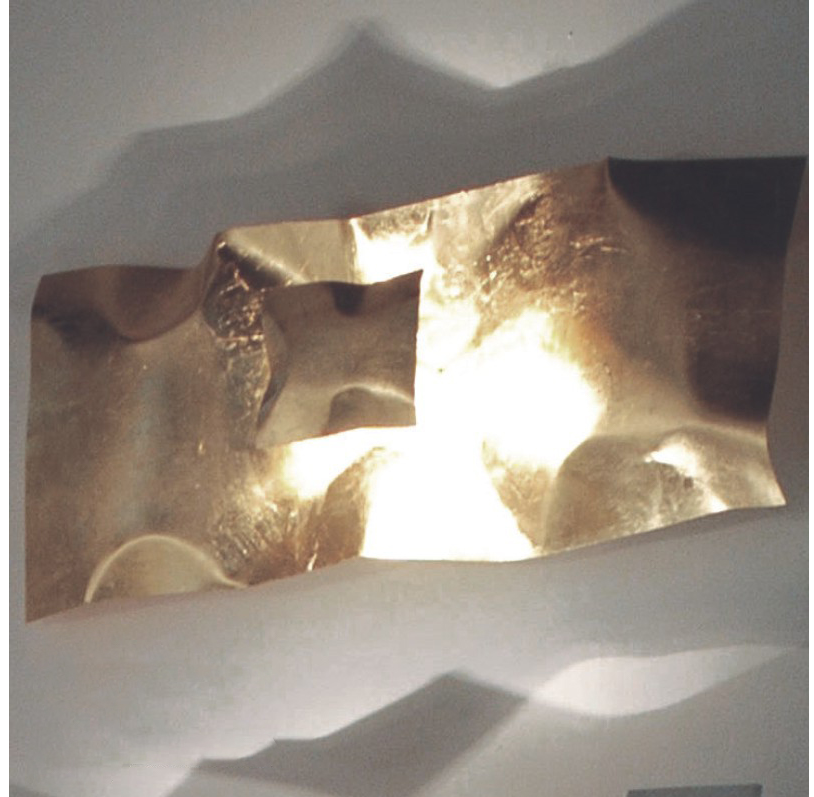

CRASH SURFACE

D133006-

base number Finish
Options

- To build a product code in our configurator select the specify button on the base model # product page
- To build a manual product code on this datasheet choose from the options listed below in blue font and add the suffix to the base model #

GENERAL

Series: Crash
 Brand: Knikerboker
 Division: Design
 Mounting Type: Surface
 Mounting Location: Wall
 Subcategory: Ambient

PHYSICAL

Shape: Abstract
 Length (mm): 2500
 Length (in): 98 7/16
 Height (mm): 2500
 Height (in): 98 7/16
 Extension (mm): 260
 Extension (in): 10 1/4
 Light Distribution: Direct / Indirect
 Fixture Finish: EWH / EBK / MAN / COF / PRD / SLF / GLF / CLF / BRL
 Fixture Material: Metal

ELECTRICAL

Lamp Type: LED
 Input Wattage (W): 31.5
 Total Output Wattage (W): 30
 Dimming: Tri-Mode (Non-Dimming and Phase Dimming (120Vac only) and 0-10V Dimming)
 Driver Included: Yes
 Driver Location: Integrated
 Driver Type: Constant Current - Universal
 Driver Class: Class 2
 Input Voltage (V): 120 - 277
 Constant Current (MA): 250
 Upon Request: 0-10Vdc dimming / Phase dimming @120Vac / 277Vac

LED

Number of LEDs: 3
 Color Temperature (°K): 3000
 Max. Delivered Lumen (lm): 540
 CRI: >85 CRI
 Lamp Life (hrs): 50000

OPTICAL

RATINGS AND CERTIFICATIONS

Certified By: Certified for North American Standards
 IP rating: IP20

PROJECT
TYPE
SPECIFIER
QUANTITY
DATE

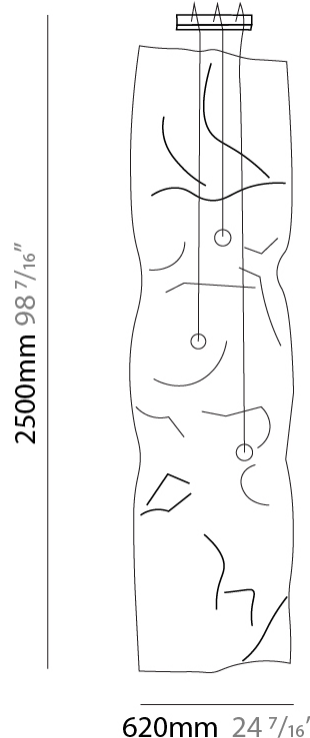

CRASH SURFACE

D133006-

PROJECT

TYPE

SPECIFIER

QUANTITY

DATE

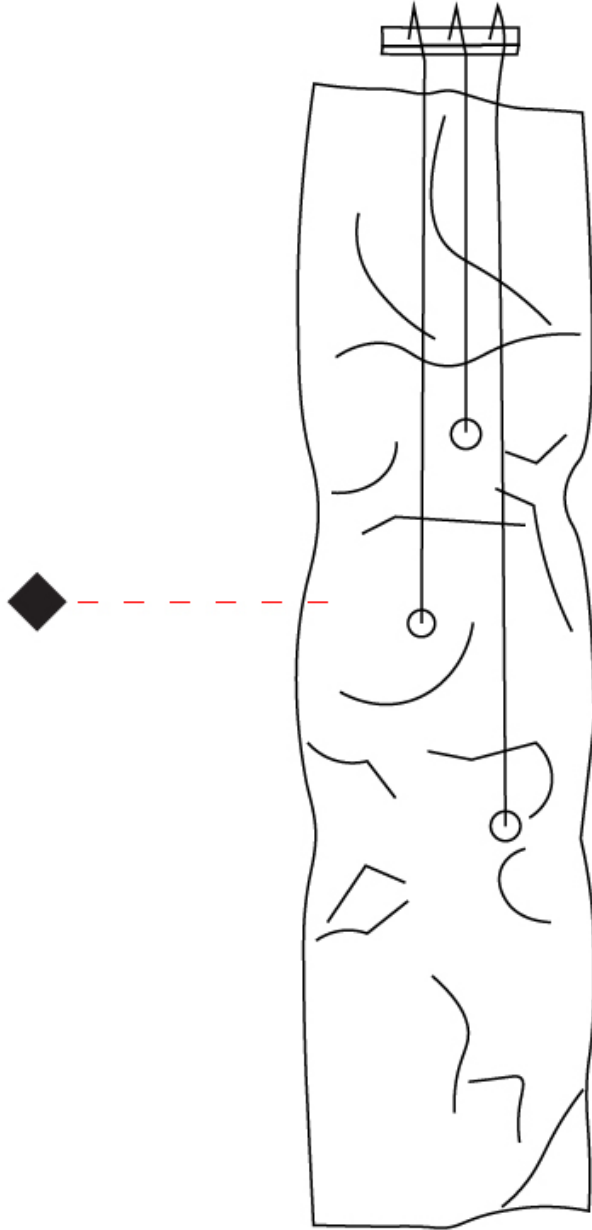

D

CRASH

COLOR FINISH CHART

Fixture Finish

Embossed White - EWH



Embossed Black - EBK

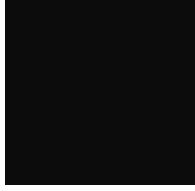

Metallic Anthracite - MAN

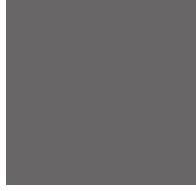

Coffee - COF

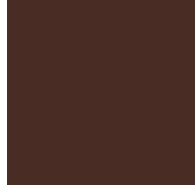

Purple Red - PRD



Silver Leaf - SLF

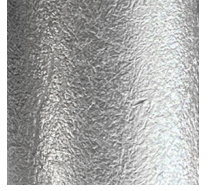

Gold Leaf - GLF



Copper Leaf - CLF

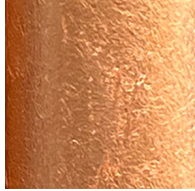

Bronze Leaf - BRL



Metallic Anthracite / Silver Leaf - MAS

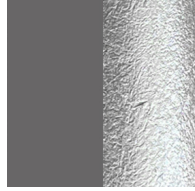

Metallic Anthracite / Gold Leaf - MAD



Metallic Anthracite / Copper Leaf - MAC



Metallic Anthracite / Bronze Leaf - MAB

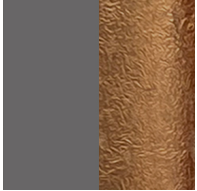

Coffee / Silver Leaf - COS

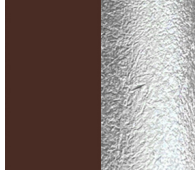

Coffee / Gold Leaf - CGO

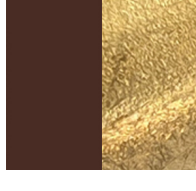

Coffee / Copper Leaf - CCL



Coffee / Bronze Leaf - CBL



Purple Red / Silver Leaf - PRS

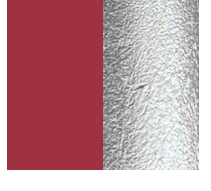

Purple Red / Gold Leaf - PRG

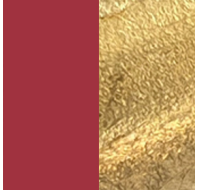

Purple Red / Copper Leaf - PRC

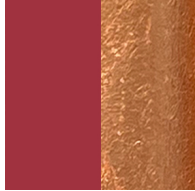

Purple Red / Bronze Leaf - PRB



Digital: Not all screens are calibrated the same, and therefore, colors will appear differently between screens.

Physical: When texture is involved, there will be variations in color, character and tone within a product series and between product families.



PROJECT	
TYPE	
SPECIFIER	
QUANTITY	
DATE	

LEGEND

	floor-mounted		pivotal		special LED (upon request) RGB, RGBW, tunable, gold+, meat+, art+, fashion+
	wall and ceiling: recessed and surface mounted		rotating		warm dim / natural dimming LED
	ceiling-mounted and wall-mounted		illuminate tilted		rechargeable battery powered
	wall-mounted		color of suspension cable		fixture with natural vivid LED (upon request)
	omni-directional light distribution		length of suspension cable		color rendering index
	direct light distribution		reflector degree selection		color temperature
	direct/indirect light distribution		super spot		lumen (luminous flux)
	indirect light distribution		lens		efficacy (lumens per watt)
	asymmetric light distribution		lens pack		Unified Glare Rating (UGR) range from 5-40
	aura light distribution		shine ring		marine grade (AISI 316 stainless steel)
	round wall or ceiling cut-out		integrated shine ring with diffuser		walk on
	square wall or ceiling cut-out		free individual colors 01-29		drive on
	the supplied jig specifies the cutout dimensions		individual colors: 00 (free of charge), 01-25 (extra charge)		Dark Sky Compliance
	minimum distance (meters) lamp - object		luminaire part to be colored (F1)		Americans with Disabilities Act (less than 4" off the wall located between 27"-84" from floor)
	recessed depth		luminaire part to be colored (F2)		lamp protected against explosion
	ceiling thickness in mm		luminaire part to be colored (F3)		blown glass using traditional methods by master glass blower
	ceiling thickness selection		luminaire part to be colored (F4)		acoustic material
	dimmable DP (phase), DV (0-10V), DD (dali), DS (step-dim)		luminaire part to be colored (F5)		protection class I, protection insulation
	included or excluded LED driver/transformer/control gear		color of 3-circuit adaptor		protection class II, protection insulation
	separately switchable		indirect diffuser		ETL Certified to UL and CSA Standards
	sensor		direct diffuser		UL Certified to UL and CSA Standards
	remote control		ball-proof (upon request)		CSA Certified to UL and CSA Standards
	available upon request		accessory		Certified for North American Standards

IP RATING

	protected against ingress of solid bodies greater than 12.5mm (finger)
	protected against ingress of solid bodies greater than 2.5mm protected against sprays of water up to 60 degrees from the vertical (rain)
	protected against ingress of solid bodies greater than 1mm (wire) no protection against the ingress of moisture
	protected against ingress of solid bodies greater than 1mm (wire) protected against sprays of water up to 60 degrees from the vertical (rain)
	protected against ingress of solid bodies greater than 1mm (wire) protected against water splashed from all directions
	protected against limited ingress of dust (wet rooms/covered outdoor areas) protected against water splashed from all directions
	protected against ingress of dust protected against jets of water
	protected against ingress of dust protected against powerful jets of water or heavy seas
	protected against ingress of dust protected against immersion of water between 15cm - 1m for 30 minutes
	protected against ingress of dust protected against immersion of water under pressure for long periods

IK RATING

	protected against 0.14 joules impact (equivalent to 0.25kg mass dropped from 56mm above the surface)
	protected against 0.2 joules impact (equivalent to 0.25kg mass dropped from 80mm above the surface)
	protected against 0.35 joules impact (equivalent to 0.25kg mass dropped from 140mm above the surface)
	protected against 0.5 joules impact (equivalent to 0.25kg mass dropped from 200mm above the surface)
	protected against 0.7 joules impact (equivalent to 0.25kg mass dropped from 280mm above the surface)
	protected against 1 joules impact (equivalent to 0.25kg mass dropped from 400mm above the surface)
	protected against 2 joules impact (equivalent to 0.5kg mass dropped from 400mm above the surface)
	protected against 5 joules impact (equivalent to 1.7kg mass dropped from 300mm above the surface)
	protected against 10 joules impact (equivalent to 5.0kg mass dropped from 200mm above the surface)
	protected against 20 joules impact (equivalent to 5.0kg mass dropped from 400mm above the surface)